

# VRF

## Technical Data Book

Duct for Latin America

(Drain pump integrated, R410A, 50/60Hz, HP/HR)



Model : AM012~048KNHPKH/AZ  
AM007~048KNLDCH/AZ  
AM018~048KNMDCH/AZ  
AM054KNMDCH1AZ

# Nomenclature

## Indoor Units

### Model Names

<b>AM</b>	<b>036</b>	<b>K</b>	<b>N</b>	<b>H</b>	<b>P</b>	<b>K</b>	<b>H</b>	/	<b>AZ</b>
(1)	(2)	(3)	(4)	(5)	(6)	(7)	(8)		Buyer

### (1) Classification

AM	VRF
----	-----

### (2) Capacity

kBtu/h (3 digits)
-------------------

### (3) Version

F	2013
H	2014
J	2015
K	2016

### (4) Product Type

N	Indoor Unit (NASA)
X	Outdoor Unit (NASA)

### (5) Product Notation

1	1Way Cassette
2	2Way Cassette
4	4Way Cassette S
N	4Way Cassette(600x600)
L	LSP Duct
M	MSP Duct
H	HSP Duct
T	Neo Forte
Q	Neo Forte(EEV)
C	Ceiling
J	Console
F	Floor Standing
K	ERV Plus
B	Hydro Unit

### (6) Feature

F	Flagship
P	Premium
D	Deluxe
S	Standard

### (7) Rating Voltage

C	208~230V, 60Hz, 1Φ
K	220~240V, 50/60Hz, 1Φ

### (8) Mode

H	Heat Pump (R410A)
R	Heat Recovery (R410A)

# 1 Specifications

## Slim Duct

Type				SLIM DUCT	SLIM DUCT	SLIM DUCT
Model				AM018KNLDCH/AZ	AM024KNLDCH/AZ	AM030KNLDCH/AZ
Power Supply			Φ, #, V, Hz	1,2,208-230,60	1,2,208-230,60	1,2,220-240,60
Mode			-	HP/HR	HP/HR	HP/HR
Performance	Capacity (Nominal)	Cooling	kW	5.28	7.03	8.79
			Btu/h	18,000	24,000	30,000
		Heating	kW	5.86	7.91	9.96
			Btu/h	20,000	27,000	34,000
Power	Power Input (Nominal)	Cooling	W	140.00	145.00	95.00
		Heating		140.00	145.00	95.00
	Current Input (Nominal)	Cooling	A	0.94	0.98	0.80
		Heating		0.94	0.98	0.80
Fan	Type		-	Sirocco Fan	Sirocco Fan	Sirocco Fan
	Motor	Output x n	W	100 x 1	110 x 1	80 x 1
	Air Flow Rate	H/M/L (UL)	CMM	15.49/13.99/12.49	16.51/15.01/13.51	31.01/25.99/22.99
			l/s	258.15/233.13/208.12	275.14/250.12/225.11	516.76/433.23/383.21
	External Static Pressure	Min / Std / Max	mmAq	0.00/1.02/4.06	0.00/1.02/4.06	0.00/1.02/6.10
			Pa	0.00/10.00/39.81	0.00/10.00/39.81	0.00/10.00/59.82
Piping Connections	Liquid Pipe		Φ,mm	6.35	9.52	9.52
			Φ, inch	1/4"	3/8"	3/8"
	Gas Pipe		Φ,mm	12.70	15.88	15.88
			Φ, inch	1/2"	5/8"	5/8"
Drain Pipe		Φ,mm	VP25 (OD 32,ID 25)	VP25 (OD 32,ID 25)	VP25 (OD 32,ID 25)	
Field Wiring	Power Source Wire		mm <sup>2</sup>	AWG 14	AWG 14	AWG 14
	Transmission Cable		mm <sup>2</sup>	2 X 16 AWG SHIELDED	2 X 16 AWG SHIELDED	2 X 16 AWG SHIELDED
Refrigerant	Type		-	R410A	R410A	R410A
	Control Method		-	EEV INCLUDED	EEV INCLUDED	EEV INCLUDED
Sound Data	Sound Pressure Level	High / Mid / Low	dB(A)	36 / 34 / 31	38 / 36 / 33	37 / 36 / 34
	Sound Power Level	Cooling		56	58	57
Dimensions	Net Weight		kg	30.5	30.5	40.5
	Shipping Weight		kg	35.5	35.5	48.0
	Net Dimensions (WxHxD)		mm	1100 x 199 x 600	1100 x 199 x 600	1300 x 295 x 690
	Shipping Dimensions (WxHxD)		mm	1350 x 280 x 710	1350 x 280 x 710	1575 x 370 x 835
Panel Size	Panel model		-	-	-	-
	Panel Net Weight		kg	-	-	-
	Shipping Weight		kg	-	-	-
	Net Dimensions (WxHxD)		mm	-	-	-
	Shipping Dimensions (WxHxD)		mm	-	-	-
Additional Accessories	Drain pump	Drain pump	-	Drain Pump Included	Drain Pump Included	Drain Pump Included
		Max. lifting Height	mm	-	-	-
	Air Filter		-	-	-	-

### NOTE

- 1) Mode : HP(Heat Pump), HR(Heat Recovery)
- 2) Nominal Capacity are based on (Equivalent refrigerant piping : 25ft , Level differences : 0ft);
  - Cooling : Indoor temperature : 80°F DB, 67°F WB / Outdoor temperature : 95°F DB, 75°F WB
  - Heating : Indoor temperature : 70°F DB, 60°F WB / Outdoor temperature : 47°F DB, 43°F WB
- 3) Sound level was acquired in an anechoic room. Thus actual noise level may be different depending on the installation conditions.
- 4) These products contain R410A which is fluorinated greenhouse gas.
- 5) Specifications may be subject to change without prior notice.

# 3 Dimensional Drawing

## Slim Duct

AM018/024KNLDCH/AZ

[Unit : mm(inch)]

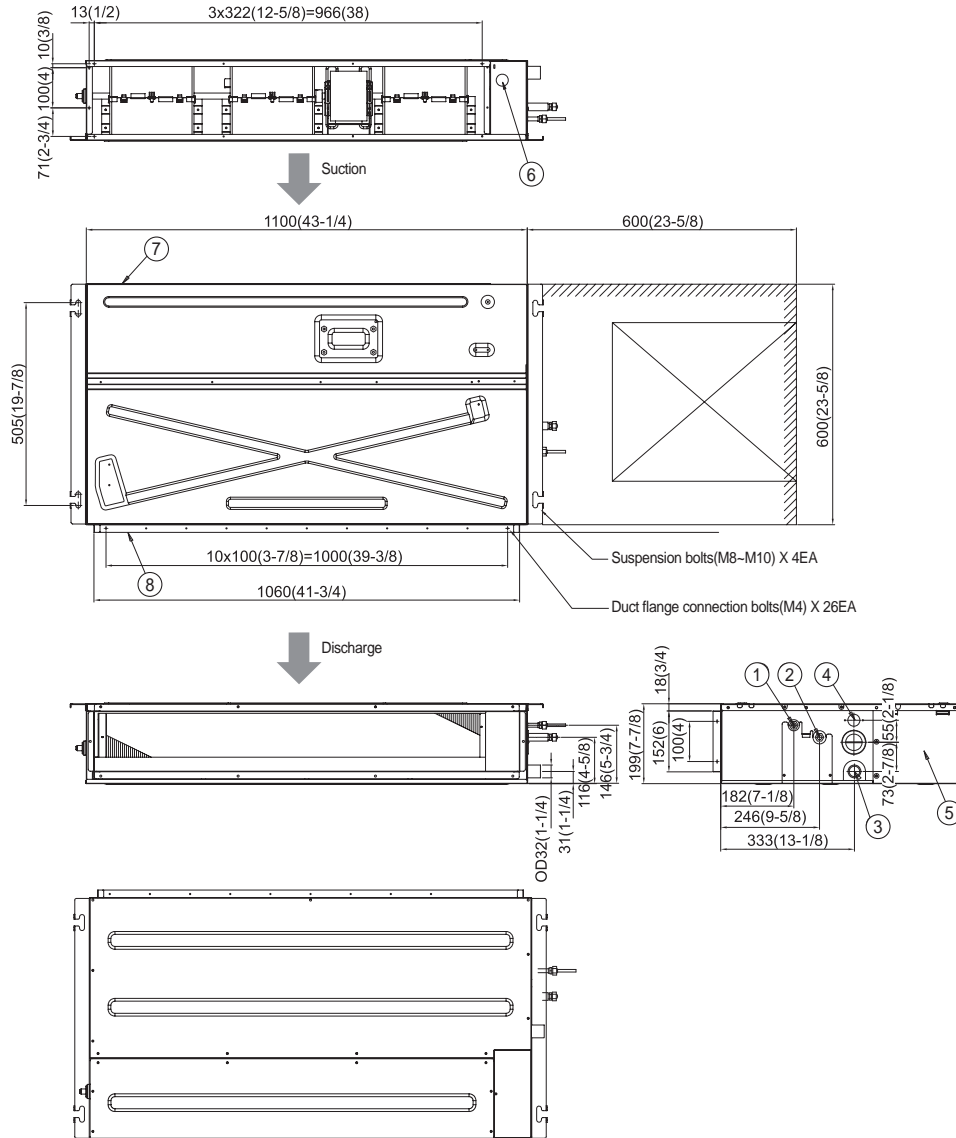

No.	Name	Description	
		18.0 MBH	24.0 MBH
①	Liquid pipe connection	Ø6.35(1/4") Flare	Ø9.52(3/8") Flare
②	Gas pipe connection	Ø12.70(1/2") Flare	Ø15.88(5/8") Flare
③	Drain pipe connection without optional drain pump	N/A	
④	Drain pipe connection with integrated drain pump	VP25 (OD 32, ID 25) / VP25 (OD 1 1/4", ID 1")	
⑤	Control unit	-	
⑥	Conduit for power supply & communication wiring	-	
⑦	Return air side	-	
⑧	Air outlet duct flange	-	

# 4 Electrical Wiring Diagram

## Slim Duct

AM007/009/012/018/024KNLDCH/AZ

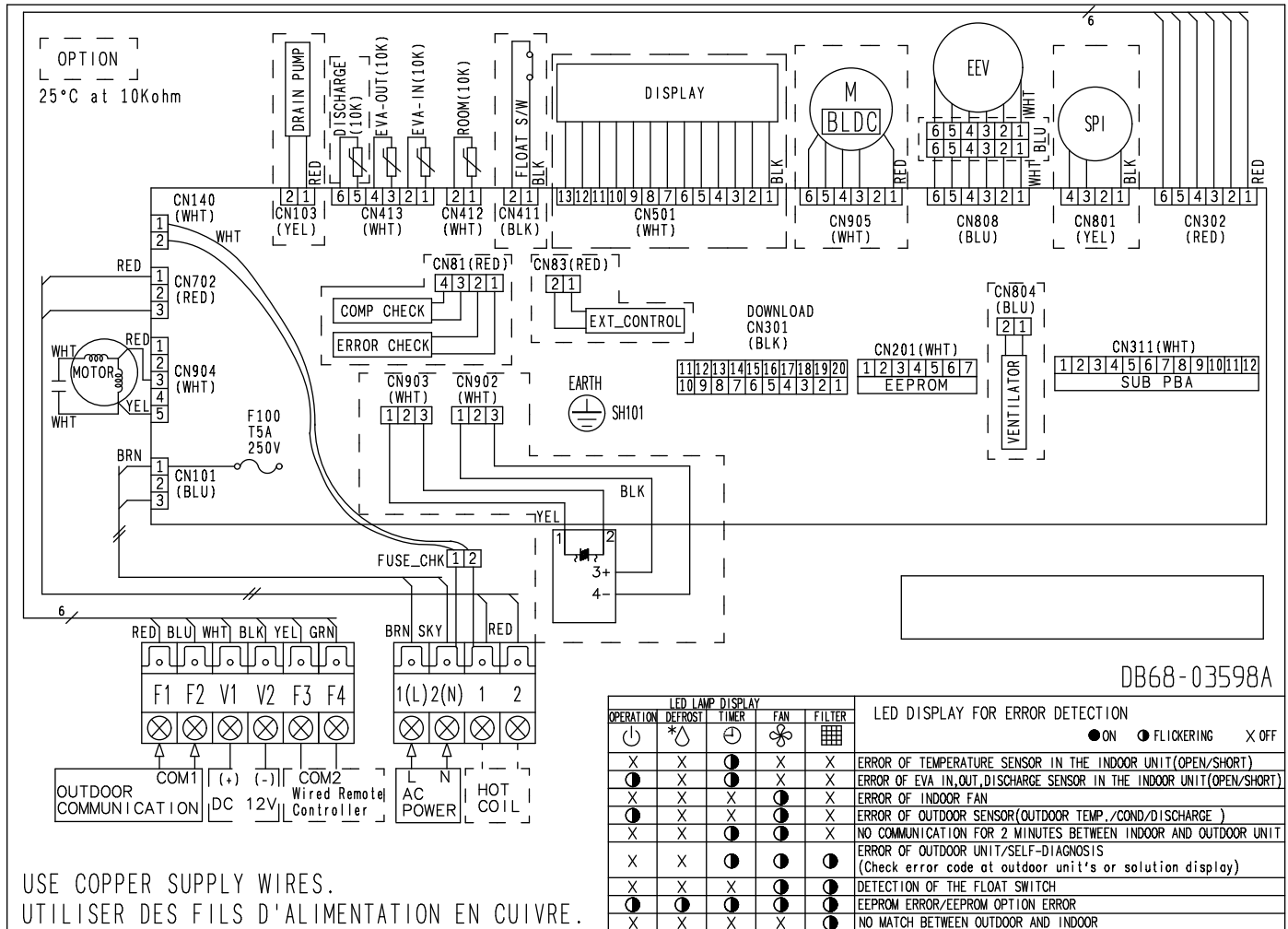

DB68-03598A

ROOM(10K)	Thermistor ROOM(10K)	EEV	electronic expansion valve	EVA-IN(10K)	Thermistor EVA IN(10K)
DISCHARGE(10K)	Thermistor DISCHARGE(10K)	SPI	S-Plasma ion	EVA-OUT(10K)	Thermistor EVA OUT(10K)

### NOTE

1. This wiring diagram applies only to the indoor unit.
2. Symbols show as follow;  
BLK : black, RED : red, BLU : blue, WHT:white, YEL : yellow, BRN : brown, SKY : sky-blue, GRN : green
3. For connection wiring indoor-outdoor transmission F1-F2, indoor-wired remotecontroller transmission F3-F4.
4. Protective earth(screw)

# 5 Sound Pressure Level

## Slim Duct

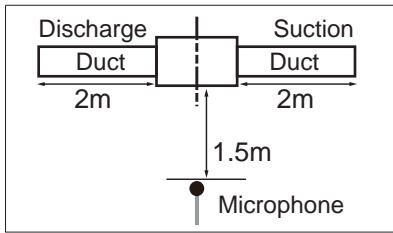

Unit: dB(A)

Model	High	Low
AM007KNLDCH/AZ	26	21
AM009KNLDCH/AZ	27	23
AM012KNLDCH/AZ	29	27
AM018KNLDCH/AZ	36	31

### Note

Specifications may be subject to change without prior notice.  
 Sound pressure level is obtained in an anechoic room.  
 Sound pressure level is a relative value, depending on the distance and acoustic environment.  
 Sound pressure level may differ depending on operation condition.  
 dBA = A-weighted sound pressure level  
 Reference acoustic pressure 0 dB= 20 uPa

## NC curve

1) AM007KNLDCH/AZ

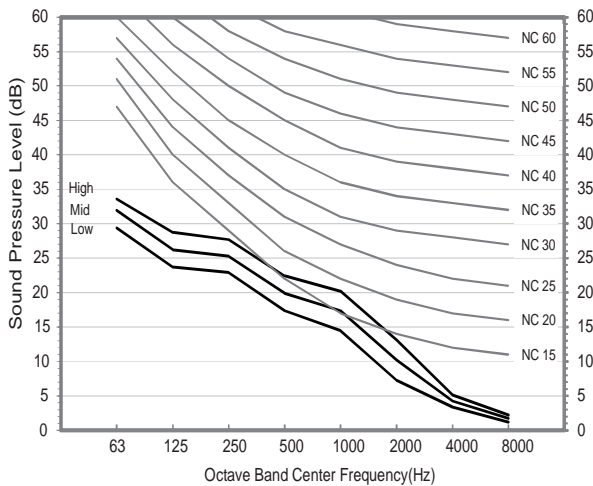

2) AM009KNLDCH/AZ

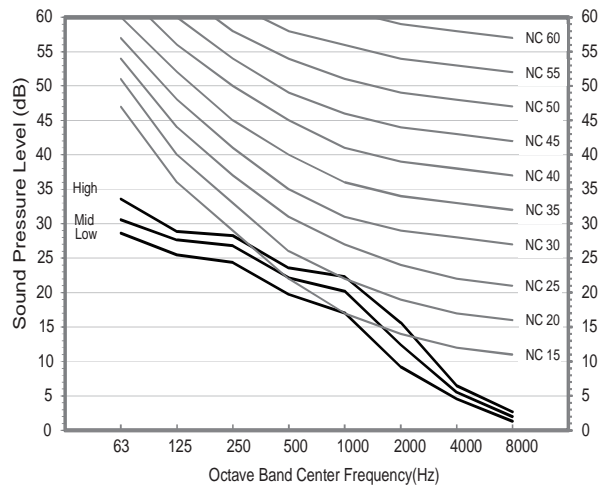

3) AM012KNLDCH/AZ

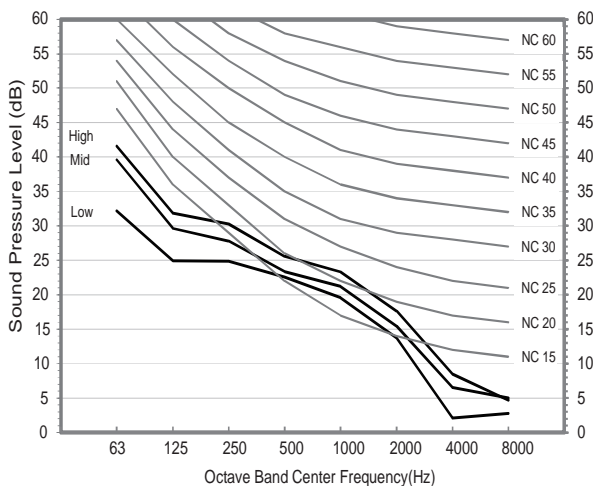

4) AM018KNLDCH/AZ

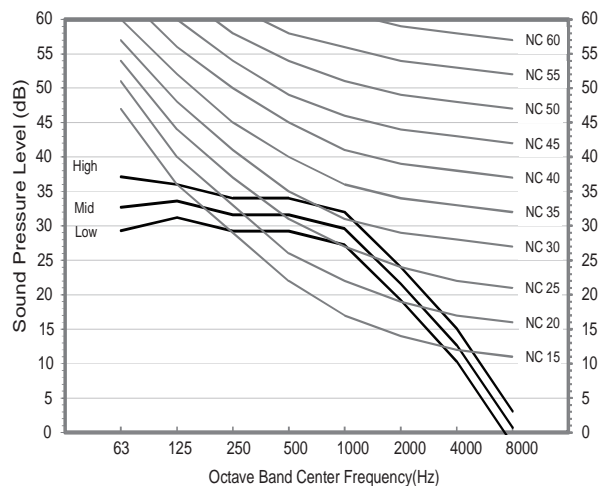

# SAMSUNG

2016. 12.  
Ver. 1.1

**Samsung Electronics Co., LTD.**  
**B2B PM**

Head Office (Suwon Korea) 129, Samsung-Ro, Yeongtong-Gu, Suwon City, Gyeonggi-Do, Korea 16677

Website : [www.samsung.com](http://www.samsung.com) [btsp.samsungsbn.com](http://btsp.samsungsbn.com) Email : [airconditioner@samsung.com](mailto:airconditioner@samsung.com)

Images and data in this book may subject to change without prior notice.

# SAMSUNG